

# **HIDROM FLEX**

S.R.L.

## **HIDRO MASTER ROMÂNIA**

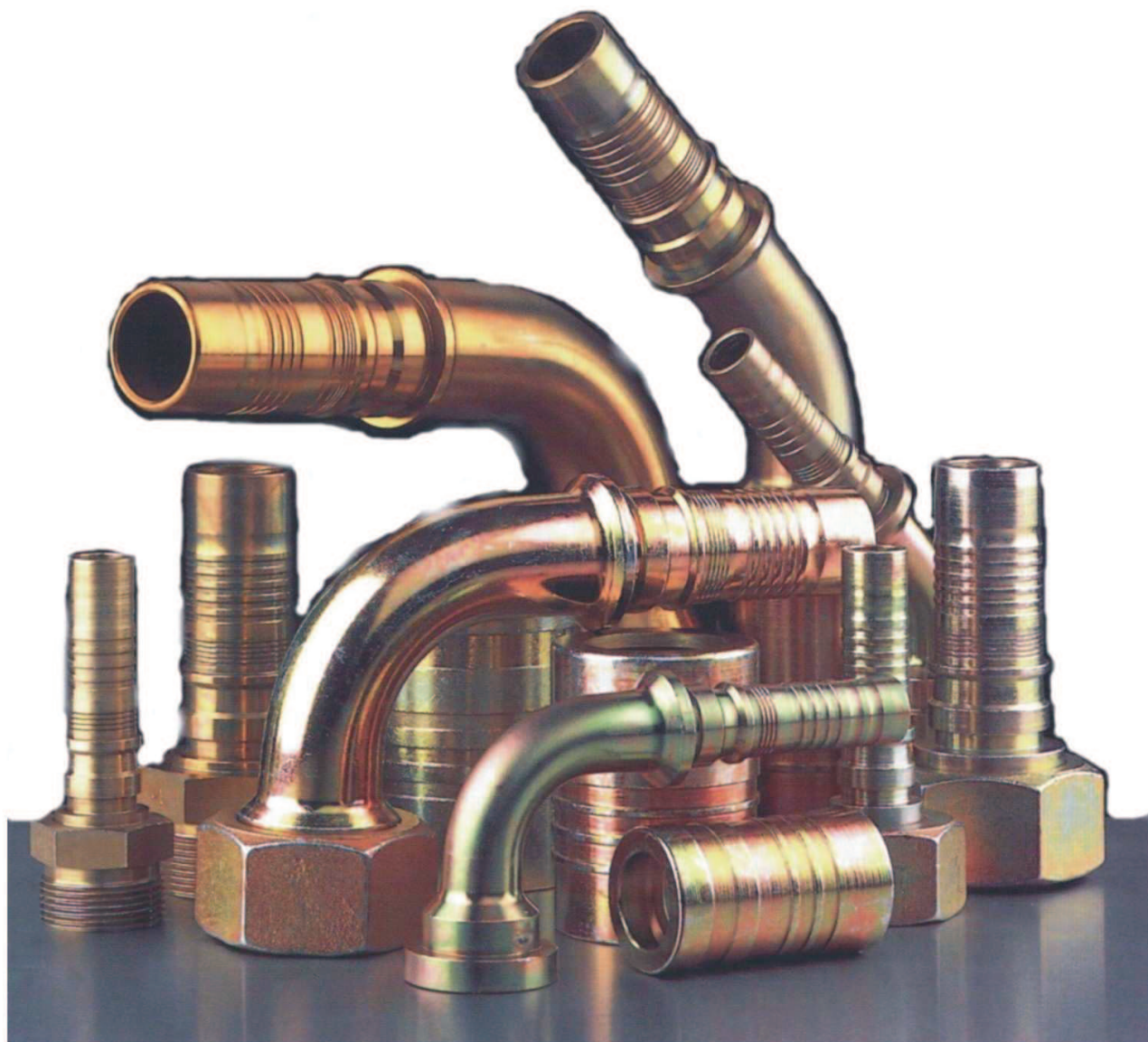

**[www.hidromflex.ro](http://www.hidromflex.ro)**

**ORADEA/BIHOR**

**Șos. Borșului Nr.7, et III. ap.7**

**(SEDIU FIRMA)**

**Tel/Fax: +40 (0) 259-421022,**

**mob: +40 (0) 748-816504**

**ALEȘD/BIHOR**

**Str. Bobâlna 16/A.**

**(PRODUCȚIE SI VÂNZARE)**

**Tel/Fax: +40 (0) 259-342424**

**mob: +40 (0) 755-223390**

**[www.sculewebshop.ro](http://www.sculewebshop.ro)**

**[www.presedefurtun.ro](http://www.presedefurtun.ro)**

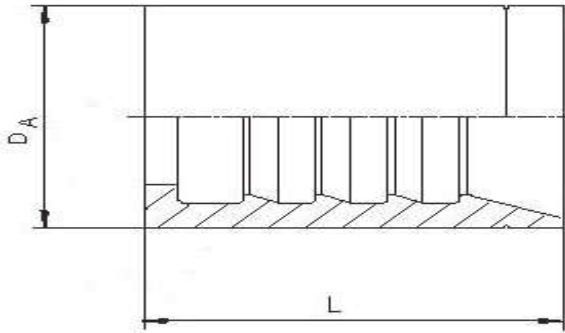

**Bucșă pentru furtun decojit 1SN/1ST**

Număr articol	Diametru furtun		DA	L	
	inch	mm (DN)			
5100 - 05	3/16"	5			
5100 - 06	1/4"	6			
5100 - 08	5/16"	8			
5100 - 10	3/8"	10			
5100 - 12	1/2"	12			
5100 - 16	5/8"	16			
5100 - 20	3/4"	20			
5100 - 25	1"	25			
5100 - 32	1.1/4"	32			
5100 - 40	1.1/2"	40			
5100 - 50	2"	50			

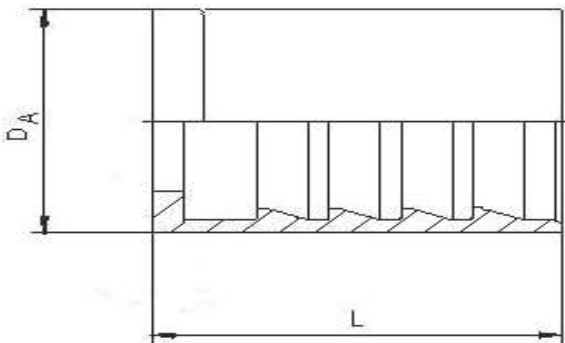

**Bucșă pentru furtun nedecojit 1SN**

Număr articol	Diametru furtun		DA	L	
	inch	mm (DN)			
5110 - 05	3/16"	5			
5110 - 06	1/4"	6			
5110 - 08	5/16"	8			
5110 - 10	3/8"	10			
5110 - 12	1/2"	12			
5110 - 16	5/8"	16			
5110 - 20	3/4"	20			
5110 - 25	1"	25			
5110 - 32	1.1/4"	32			

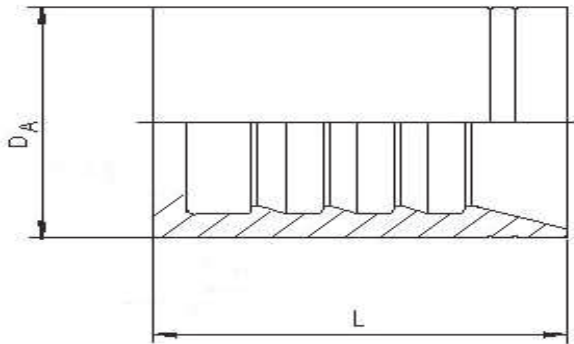

**Bucșă pentru furtun decojit 2SN/2ST**

Număr articol	Diametru furtun		DA	L	
	inch	mm (DN)			
5200 - 05	3/16"	5			
5200 - 06	1/4"	6			
5200 - 08	5/16"	8			
5200 - 10	3/8"	10			
5200 - 12	1/2"	12			
5200 - 16	5/8"	16			
5200 - 20	3/4"	20			
5200 - 25	1"	25			
5200 - 32	1.1/4"	32			
5200 - 40	1.1/2"	40			
5200 - 50	2"	50			

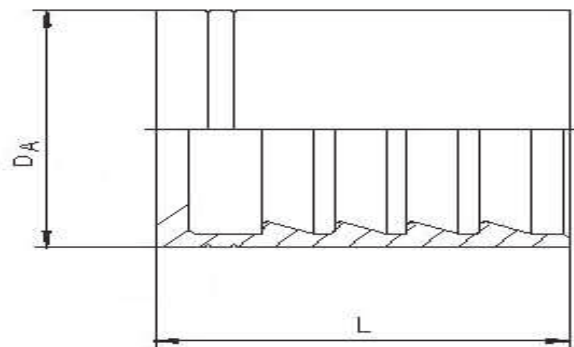

**Bucșă pentru furtun nedecojit 2SN**

Număr articol	Diametru furtun		DA	L	
	inch	mm (DN)			
5220 - 05	3/16"	5			
5220 - 06	1/4"	6			
5220 - 08	5/16"	8			
5220 - 10	3/8"	10			
5220 - 12	1/2"	12			
5220 - 16	5/8"	16			
5220 - 20	3/4"	20			
5220 - 25	1"	25			
5220 - 32	1.1/4"	32			

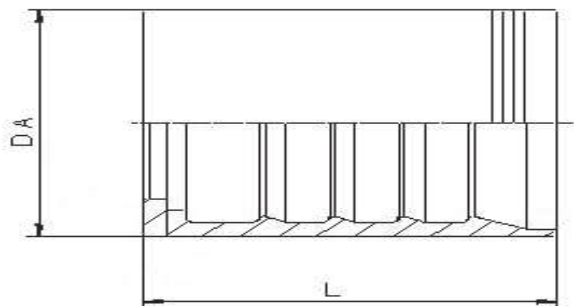

**Bucșă pentru furtun decojit 4SP**

Număr articol	Diametru furtun		DA	L	
	inch	mm (DN)			
5404 - 06	1/4"	6			
5404 - 10	3/8"	10			
5404 - 12	1/2"	12			
5404 - 16	5/8"	16			
5404 - 20	3/4"	20			
5404 - 25	1"	25			
5404 - 32	1.1/4"	32			
5404 - 40	1.1/2"	40			
5404 - 50	2"	50			

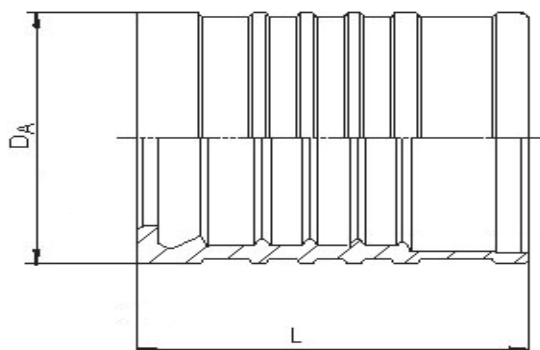

**Bucșă pentru furtun decojit 4SH**

Număr articol	Diametru furtun		DA	L	
	inch	mm (DN)			
5402 - 20	3/4"	20			
5402 - 25	1"	25			
5402 - 32	1.1/4"	32			
5402 - 40	1.1/2"	40			
5402 - 50	2"	50			
<b>Bucșe pentru armături italienești ( vă rugăm contactați colegii noștri ! )</b>					
5422 - 20	3/4"	20			
5422 - 25	1"	25			
5422 - 32	1.1/4"	32			
5422 - 40	1.1/2"	40			
5422 - 50	2"	50			

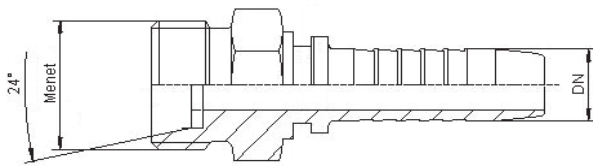

( CEL )  
**Armătură cu filet exterior metric  
 con 24°**

Număr articol	Diametru furtun		Diametru filet	
	inch	mm (DN)		
1100 - 05	3/16"	5	M 12x1,5	
1100 - 06	1/4"	6	M 14x1,5	
1100 - 06/05	1/4"	6	M 12x1,5	
1100 - 06/08	1/4"	6	M 16x1,5	
1100 - 06/10	1/4"	6	M 18x1,5	
1100 - 08	5/16"	8	M 18x1,5	
1100 - 08/06	5/16"	8	M 14x1,5	
1100 - 08/10	5/16"	8	M 18x1,5	
1100 - 10	3/8"	10	M 18x1,5	
1100 - 10/08	3/8"	10	M 16x1,5	
1100 - 10/12	3/8"	10	M 22x1,5	
1100 - 12	1/2"	12	M 22x1,5	
1100 - 12/10	1/2"	12	M 18x1,5	
1100 - 12/16	1/2"	12	M 26x1,5	
1100 - 16	5/8"	16	M 26x1,5	
1100 - 16/20	5/8"	16	M 30x2	
1100 - 20	3/4"	20	M 30x2	
1100 - 20/25	3/4"	20	M 36x2	
1100 - 25	1"	25	M 36x2	
1100 - 25/20	1"	25	M 30x2	
1100 - 25/32	1"	25	M 42x2	
1100 - 32	1.1/4"	32	M 42x2	
1100 - 32/40	1.1/4"	32	M 52x2	
1100 - 40	1.1/2"	40	M 52x2	

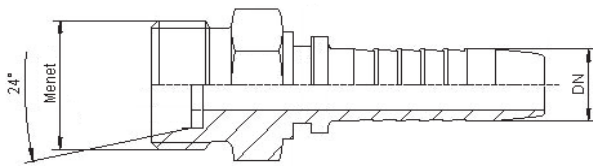

( CES )  
**Armătură cu filet exterior cu filet metric  
 con 24° în variantă întărită**

Număr articol	Diametru furtun		Diametru filet	
	inch	mm (DN)		
1110 - 05	3/16"	5	M 16x1,5	
1110 - 06	1/4"	6	M 18x1,8	
1110 - 06/05	1/4"	6	M 16x1,5	
1110 - 06/08	1/4"	6	M 20x1,5	
1110 - 08	5/16"	8	M 20x1,5	
1110 - 08/06	5/16"	8	M 18x1,5	
1110 - 08/10	5/16"	8	M 22x1,5	
1110 - 10	3/8"	10	M 22x1,5	
1110 - 10/08	3/8"	10	M 20x1,5	
1110 - 10/12	3/8"	10	M 24x1,5	
1110 - 12	1/2"	12	M 24x1,5	
1110 - 12/10	1/2"	12	M 22x1,5	
1110 - 12/16	1/2"	12	M 30x2	
1110 - 16	5/8"	16	M 30x2	
1110 - 16/20	5/8"	16	M 36x2	
1110 - 20	3/4"	20	M 36x2	
1110 - 20/25	3/4"	20	M 42x2	
1110 - 25	1"	25	M 42x2	
1110 - 25/20	1"	25	M 36x2	
1110 - 25/32	1"	25	M 52x2	
1110 - 32	1.1/4"	32	M 52x2	

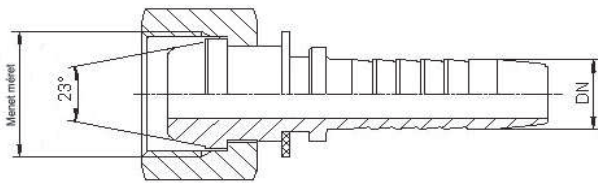

( DKL )  
**Armătură cu piuliță filet metric, con 23°  
 fără inel O**

Număr articol	Diametru furtun		Diametru filet	
	inch	mm (DN)		
1200 - 06	1/4"	6	M 14x1,5	
1200 - 08	5/16"	8	M 18x1,5	
1200 - 10	3/8"	10	M 18x1,5	
1200 - 12	1/2"	12	M 22x1,5	
1200 - 16	5/8"	16	M 26x1,5	
1201 - 16	5/8"	16	M 27x1,5	
1202 - 16	5/8"	16	M 27x2	
1200 - 20	3/4"	20	M 30x2	
1200 - 25	1"	25	M 36x2	

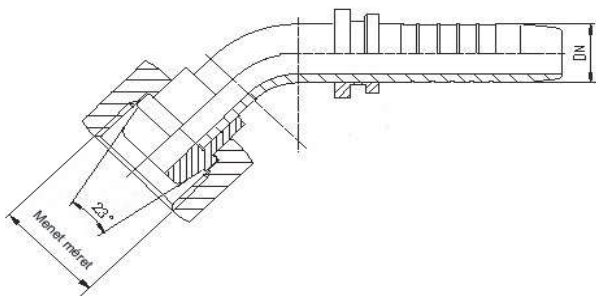

( DKL )  
**Armătură cu piuliță filet metric, con 23°  
 fără inel O, la 45°**

Număr articol	Diametru furtun		Diametru filet	
	inch	mm (DN)		
1200 - 06 - 45	1/4"	6	M 14x1,5	
1200 - 08 - 45	5/16"	8	M 18x1,5	
1200 - 10 - 45	3/8"	10	M 18x1,5	
1200 - 12 - 45	1/2"	12	M 22x1,5	
1200 - 16 - 45	5/8"	16	M 26x1,5	
1200 - 20 - 45	3/4"	20	M 30x2	
1200 - 25 - 45	1"	25	M 36x2	
1200 - 32 - 45	1.1/4"	32	M 42x2	

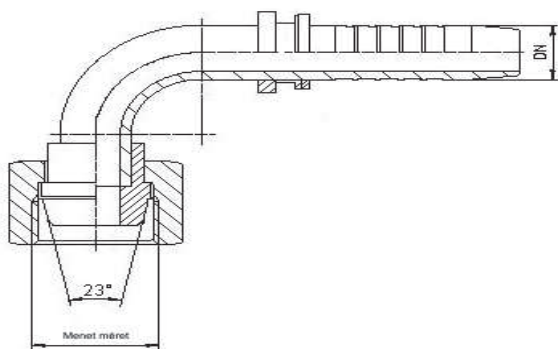

**( DKL )**  
**Armătură cu piuliță filet metric, con 23°**  
**fără inel O, la90°**

Număr articol	Diametru furtun		Diametru filet	
	inch	mm (DN)		
1200 - 06 - 90	1/4"	6	M 14x1,5	
1200 - 08 - 90	5/16"	8	M 18x1,5	
1200 - 10 - 90	3/8"	10	M 18x1,5	
1200 - 12 - 90	1/2"	12	M 22x1,5	
1200 - 16 - 90	5/8"	16	M 26x1,5	
1200 - 20 - 90	3/4"	20	M 30x2	
1200 - 25 - 90	1"	25	M 36x2	
1200 - 32 - 90	1.1/4"	32	M 42x2	

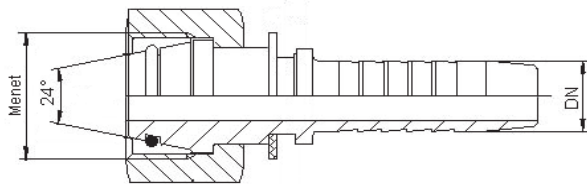

( DKOL )  
**Armătură cu piuliță filet metric de  
 execuție ușoară, con 24°**

Număr articol	Diametru furtun		Diametru filet	
	inch	mm (DN)		
1220 - 05	3/16"	5	M 12x1,5	
1220 - 06	1/4"	6	M 14x1,5	
1220 - 06/05	1/4"	6	M 12x1,5	
1220 - 06/08	1/4"	6	M 16x1,5	
1220 - 06/10	1/4"	6	M 18x1,5	
1220 - 08	5/16"	8	M 18x1,5	
1220 - 08/06	5/16"	8	M 14x1,5	
1220 - 08/10	5/16"	8	M 18x1,5	
1220 - 10	3/8"	10	M 18x1,5	
1220 - 10/08	3/8"	10	M 16x1,5	
1220 - 10/12	3/8"	10	M 22x1,5	
1220 - 12	1/2"	12	M 22x1,5	
1220 - 12/10	1/2"	12	M 18x1,5	
1220 - 12/16	1/2"	12	M 26x1,5	
1220 - 16/12	5/8"	16	M 22x1,5	
1220 - 16	5/8"	16	M 26x1,5	
1220 - 16/20	5/8"	16	M 30x2	
1221 - 16	5/8"	16	M 27x1,5	
1222 - 16	5/8"	16	M 27x2	
1220 - 20	3/4"	20	M 30x2	
1220 - 20/16	3/4"	20	M 26x1,5	
1220 - 20/25	3/4"	20	M 36x2	
1221 - 20	3/4"	20	M 30x1,5	
1220 - 25	1"	25	M 36x2	
1220 - 25/20	1"	25	M 30x2	
1220 - 25/32	1"	25	M 42x2	
1220 - 32	1.1/4"	32	M 42x2	
1220 - 32/40	1.1/4"	32	M 52x2	
1220 - 40	1.1/2"	40	M 52x2	

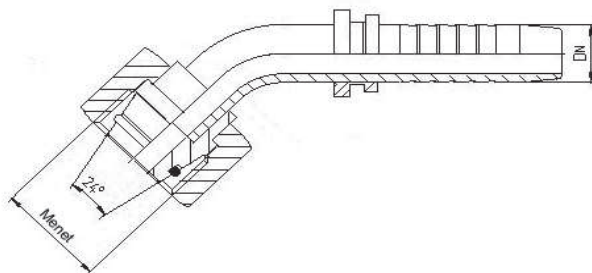

( DKOL )  
**Armătură cu piuliță filet metric de  
 execuție ușoară, con 24°, la45°**

Număr articol	Diametru furtun		Diametru filet	
	inch	mm (DN)		
1220 - 05 - 45	3/16"	5	M 12x1,5	
1220 - 06 - 45	1/4"	6	M 14x1,5	
1220 - 06/05 - 45	1/4"	6	M 12x1,5	
1220 - 06/08 - 45	1/4"	6	M 16x1,5	
1220 - 06/10 - 45	1/4"	6	M 18x1,5	
1220 - 08 - 45	5/16"	8	M 18x1,5	
1220 - 08/06 - 45	5/16"	8	M 14x1,5	
1220 - 08/10 - 45	5/16"	8	M 18x1,5	
1220 - 10 - 45	3/8"	10	M 18x1,5	
1220 - 10/08 - 45	3/8"	10	M 16x1,5	
1220 - 10/12 - 45	3/8"	10	M 22x1,5	
1220 - 12 - 45	1/2"	12	M 22x1,5	
1220 - 12/10 - 45	1/2"	12	M 18x1,5	
1220 - 12/16 - 45	1/2"	12	M 26x1,5	
1220 - 16/12 - 45	5/8"	16	M 22x1,5	
1220 - 16 - 45	5/8"	16	M 26x1,5	
1220 - 16/20 - 45	5/8"	16	M 30x2	
1220 - 20 - 45	3/4"	20	M 30x2	
1220 - 20/16 - 45	3/4"	20	M 26x1,5	
1220 - 20/25 - 45	3/4"	20	M 36x2	
1220 - 25 - 45	1"	25	M 36x2	
1220 - 25/20 - 45	1"	25	M 30x2	
1220 - 25/32 - 45	1"	25	M 42x2	
1220 - 32 - 45	1.1/4"	32	M 42x2	
1220 - 32/40 - 45	1.1/4"	32	M 52x2	
1220 - 40 - 45	1.1/2"	40	M 52x2	

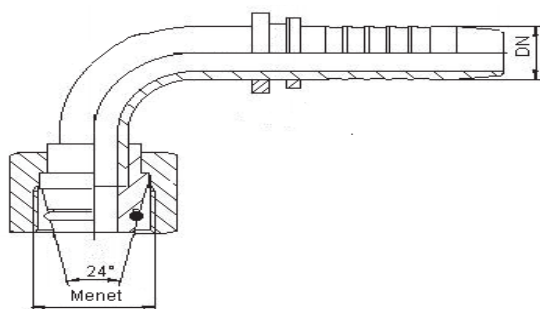

( DKOL )  
**Armătură cu piuliță filet metric de  
 execuție ușoară, con 24° la 90°**

Număr articol	Diametru furtun		Diametru filet	
	inch	mm (DN)		
1220 - 05 - 90	3/16"	5	M 12x1,5	
1220 - 06 - 90	1/4"	6	M 14x1,5	
1220 - 06/05 - 90	1/4"	6	M 12x1,5	
1220 - 06/08 - 90	1/4"	6	M 16x1,5	
1220 - 06/10 - 90	1/4"	6	M 18x1,5	
1220 - 08 - 90	5/16"	8	M 18x1,5	
1220 - 08/06 - 90	5/16"	8	M 14x1,5	
1220 - 08/10 - 90	5/16"	8	M 18x1,5	
1220 - 10 - 90	3/8"	10	M 18x1,5	
1220 - 10/08 - 90	3/8"	10	M 16x1,5	
1220 - 10/12 - 90	3/8"	10	M 22x1,5	
1220 - 12 - 90	1/2"	12	M 22x1,5	
1220 - 12/10 - 90	1/2"	12	M 18x1,5	
1220 - 12/16 - 90	1/2"	12	M 26x1,5	
1220 - 16/12 - 90	5/8"	16	M 22x1,5	
1220 - 16 - 90	5/8"	16	M 26x1,5	
1220 - 16/20 - 90	5/8"	16	M 30x2	
1220 - 20 - 90	3/4"	20	M 30x2	
1220 - 20/16 - 90	3/4"	20	M 26x1,5	
1220 - 20/25 - 90	3/4"	20	M 36x2	
1220 - 25 - 90	1"	25	M 36x2	
1220 - 25/20 - 90	1"	25	M 30x2	
1220 - 25/32 - 90	1"	25	M 42x2	
1220 - 32 - 90	1.1/4"	32	M 42x2	
1220 - 32/40 - 90	1.1/4"	32	M 52x2	
1220 - 40 - 90	1.1/2"	40	M 52x2	

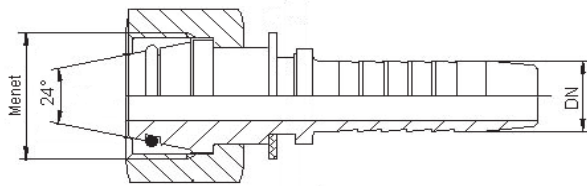

**( DKOS )**  
**Armătură cu piuliță filet metric cu con de**  
**24° de execuție grea**

Număr articol	Diametru furtun		Diametru filet	
	inch	mm (DN)		
1230 - 05	3/16"	5	M 16x1,5	
1230 - 06	1/4"	6	M 18x1,8	
1230 06/04	1/4"	6	M 14x1,5	
1230 - 06/05	1/4"	6	M 16x1,5	
1230 - 06/08	1/4"	6	M 20x1,5	
1230 - 08	5/16"	8	M 20x1,5	
1230 - 08/06	5/16"	8	M 18x1,5	
1230 - 10	3/8"	10	M 22x1,5	
1230 - 10/08	3/8"	10	M 20x1,5	
1230 - 10/12	3/8"	10	M 24x1,5	
1230 - 12	1/2"	12	M 24x1,5	
1230 - 12/10	1/2"	12	M 22x1,5	
1230 - 12/16	1/2"	12	M 30x2	
1230 - 16	5/8"	16	M 30x2	
1230 - 16/12	5/8"	16	M 24x1,5	
1230 - 16/20	5/8"	16	M 36x2	
1230 - 20	3/4"	20	M 36x2	
1230 - 20/16	3/4"	20	M 30x2	
1230 - 20/25	3/4"	20	M 42x2	
1230 - 25	1"	25	M 42x2	
1230 - 25/20	1"	25	M 36x2	
1230 - 32	1.1/4"	32	M 52x2	

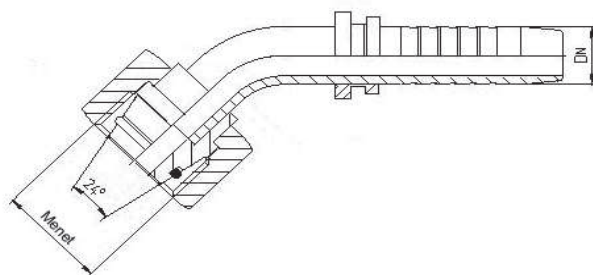

**( DKOS )**  
**Armătură cu piuliță filet metric cu con de**  
**24° de execuție grea la45°**

Număr articol	Diametru furtun		Diametru filet	
	inch	mm (DN)		
1230 - 05 - 45	3/16"	5	M 16x1,5	
1230 - 06 - 45	1/4"	6	M 18x1,8	
1230 - 06/04 - 45	1/4"	6	M 14x1,5	
1230 - 06/05 - 45	1/4"	6	M 16x1,5	
1230 - 06/08 - 45	1/4"	6	M 20x1,5	
1230 - 08 - 45	5/16"	8	M 20x1,5	
1230 - 08/06 - 45	5/16"	8	M 18x1,5	
1230 - 10 - 45	3/8"	10	M 22x1,5	
1230 - 10/08 - 45	3/8"	10	M 20x1,5	
1230 - 10/12 - 45	3/8"	10	M 24x1,5	
1230 - 12 - 45	1/2"	12	M 24x1,5	
1230 - 12/10 - 45	1/2"	12	M 22x1,5	
1230 - 12/16 - 45	1/2"	12	M 30x2	
1230 - 16 - 45	5/8"	16	M 30x2	
1230 - 16/12 - 45	5/8"	16	M 24x1,5	
1230 - 16/20 - 45	5/8"	16	M 36x2	
1230 - 20 - 45	3/4"	20	M 36x2	
1230 - 20/16 - 45	3/4"	20	M 30x2	
1230 - 20/25 - 45	3/4"	20	M 42x2	
1230 - 25 - 45	1"	25	M 42x2	
1230 - 25/20 - 45	1"	25	M 36x2	
1230 - 32 - 45	1.1/4"	32	M 52x2	

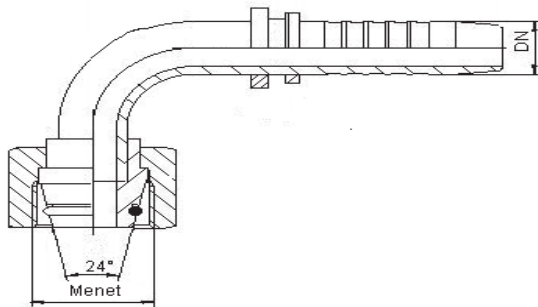

**( DKOS )**  
**Armătură cu piuliță filet metric cu con de**  
**24° de execuție grea la 90°**

Număr articol	Diametru furtun		Diametru filet	
	inch	mm (DN)		
1230 - 05 - 90	3/16"	5	M 16x1,5	
1230 - 06 - 90	1/4"	6	M 18x1,8	
1230 06/04 - 90	1/4"	6	M 14x1,5	
1230 - 06/05 - 90	1/4"	6	M 16x1,5	
1230 - 06/08 - 90	1/4"	6	M 20x1,5	
1230 - 08 - 90	5/16"	8	M 20x1,5	
1230 - 08/06 - 90	5/16"	8	M 18x1,5	
1230 - 10 - 90	3/8"	10	M 22x1,5	
1230 - 10/08 - 90	3/8"	10	M 20x1,5	
1230 - 10/12 - 90	3/8"	10	M 24x1,5	
1230 - 12 - 90	1/2"	12	M 24x1,5	
1230 - 12/10 - 90	1/2"	12	M 22x1,5	
1230 - 12/16 - 90	1/2"	12	M 30x2	
1230 - 16 - 90	5/8"	16	M 30x2	
1230 - 16/12 - 90	5/8"	16	M 24x1,5	
1230 - 16/20 - 90	5/8"	16	M 36x2	
1230 - 20 - 90	3/4"	20	M 36x2	
1230 - 20/16 - 90	3/4"	20	M 30x2	
1230 - 20/25 - 90	3/4"	20	M 42x2	
1230 - 25 - 90	1"	25	M 42x2	
1230 - 25/20 - 90	1"	25	M 36x2	
1230 - 32 - 90	1.1/4"	32	M 52x2	

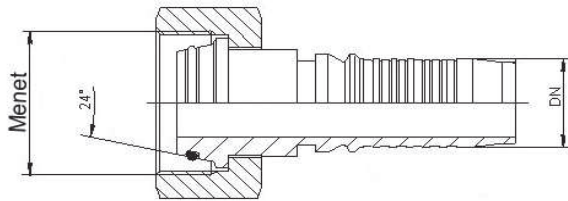

**( DKOS )**  
**Armatura cu piuliță filet metric cu con**  
**24° antismulgere, 4SH**

Număr articol	Diametru furtun		Diametru filet	
	inch	mm (DN)		
1232 - 05	3/16"	5	M 16x1,5	
1232 - 06	1/4"	6	M 18x1,8	
1232 06/04	1/4"	6	M 14x1,5	
1232 - 06/05	1/4"	6	M 16x1,5	
1232 - 06/08	1/4"	6	M 20x1,5	
1232 - 08	5/16"	8	M 20x1,5	
1232 - 08/06	5/16"	8	M 18x1,5	
1232 - 10	3/8"	10	M 22x1,5	
1232 - 10/08	3/8"	10	M 20x1,5	
1232 - 10/12	3/8"	10	M 24x1,5	
1232 - 12	1/2"	12	M 24x1,5	
1232 - 12/10	1/2"	12	M 22x1,5	
1232 - 12/16	1/2"	12	M 30x2	
1232 - 16	5/8"	16	M 30x2	
1232 - 16/12	5/8"	16	M 24x1,5	
1232 - 16/20	5/8"	16	M 36x2	
1232 - 20	3/4"	20	M 36x2	
1232 - 20/16	3/4"	20	M 30x2	
1232 - 20/25	3/4"	20	M 42x2	
1232 - 25	1"	25	M 42x2	
1232 - 25/20	1"	25	M 36x2	
1232 - 32	1.1/4"	32	M 52x2	

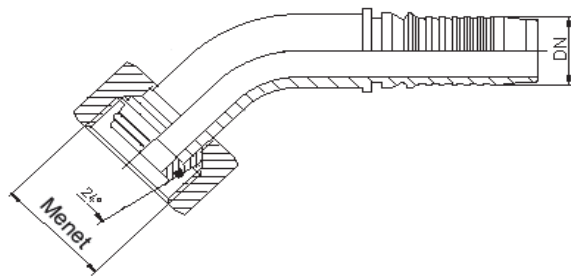

( DKOS )  
**Armatura cu piuliță filet metric cu con  
 24° antismulgere, 4SH la 45°**

Număr articol	Diametru furtun		Diametru filet	
	inch	mm (DN)		
1232 - 05 - 45	3/16"	5	M 16x1,5	
1232 - 06 - 45	1/4"	6	M 18x1,8	
1232 - 06/04 - 45	1/4"	6	M 14x1,5	
1232 - 06/05 - 45	1/4"	6	M 16x1,5	
1232 - 06/08 - 45	1/4"	6	M 20x1,5	
1232 - 08 - 45	5/16"	8	M 20x1,5	
1232 - 08/06 - 45	5/16"	8	M 18x1,5	
1232 - 10 - 45	3/8"	10	M 22x1,5	
1232 - 10/08 - 45	3/8"	10	M 20x1,5	
1232 - 10/12 - 45	3/8"	10	M 24x1,5	
1232 - 12 - 45	1/2"	12	M 24x1,5	
1232 - 12/10 - 45	1/2"	12	M 22x1,5	
1232 - 12/16 - 45	1/2"	12	M 30x2	
1232 - 16 - 45	5/8"	16	M 30x2	
1232 - 16/12 - 45	5/8"	16	M 24x1,5	
1232 - 16/20 - 45	5/8"	16	M 36x2	
1232 - 20 - 45	3/4"	20	M 36x2	
1232 - 20/16 - 45	3/4"	20	M 30x2	
1232 - 20/25 - 45	3/4"	20	M 42x2	
1232 - 25 - 45	1"	25	M 42x2	
1232 - 25/20 - 45	1"	25	M 36x2	
1232 - 32 - 45	1.1/4"	32	M 52x2	

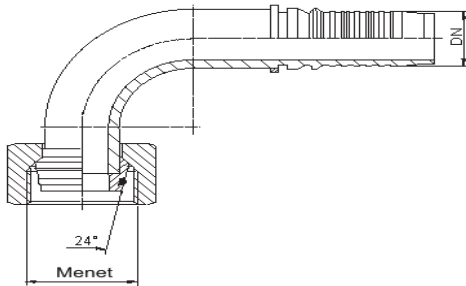

( DKOS )  
**Armatura cu piuliță filet metric cu con  
 24° antismulgere, 4SH la 90°**

Număr articol	Diametru furtun		Diametru filet	
	inch	mm (DN)		
1232 - 05 - 90	3/16"	5	M 16x1,5	
1232 - 06 - 90	1/4"	6	M 18x1,8	
1232 06/04 - 90	1/4"	6	M 14x1,5	
1232 - 06/05 - 90	1/4"	6	M 16x1,5	
1232 - 06/08 - 90	1/4"	6	M 20x1,5	
1232 - 08 - 90	5/16"	8	M 20x1,5	
1232 - 08/06 - 90	5/16"	8	M 18x1,5	
1232 - 10 - 90	3/8"	10	M 22x1,5	
1232 - 10/08 - 90	3/8"	10	M 20x1,5	
1232 - 10/12 - 90	3/8"	10	M 24x1,5	
1232 - 12 - 90	1/2"	12	M 24x1,5	
1232 - 12/10 - 90	1/2"	12	M 22x1,5	
1232 - 12/16 - 90	1/2"	12	M 30x2	
1232 - 16 - 90	5/8"	16	M 30x2	
1232 - 16/12 - 90	5/8"	16	M 24x1,5	
1232 - 16/20 - 90	5/8"	16	M 36x2	
1232 - 20 - 90	3/4"	20	M 36x2	
1232 - 20/16 - 90	3/4"	20	M 30x2	
1232 - 20/25 - 90	3/4"	20	M 42x2	
1232 - 25 - 90	1"	25	M 42x2	
1232 - 25/20 - 90	1"	25	M 36x2	
1232 - 32 - 90	1.1/4"	32	M 52x2	

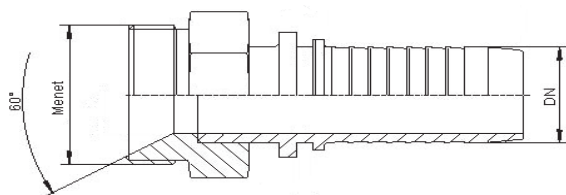

( AGR )  
**Armătură cu filet exterior BSP in țol  
 con 60°**

Număr articol	Diametru furtun		Diametru filet	
	inch	mm (DN)		
1300 - 05	3/16"	5	BSP 1/8"	
1300 - 06	1/4"	6	BSP 1/4"	
1300 - 06/05	1/4"	6	BSP 1/8"	
1300 - 06/10	1/4"	6	BSP 3/8"	
1300 - 08/06	5/16"	8	BSP 1/4"	
1300 - 08/10	5/16"	8	BSP 3/8"	
1300 - 10	3/8"	10	BSP 3/8"	
1300 - 10/12	3/8"	10	BSP 1/2"	
1300 - 12	1/2"	12	BSP 1/2"	
1300 - 12/10	1/2"	12	BSP 3/8"	
1300 - 12/16	1/2"	12	BSP 5/8"	
1300 - 16	5/8"	16	BSP 5/8"	
1300 - 16/20	5/8"	16	BSP 3/4"	
1300 - 20	3/4"	20	BSP 3/4"	
1300 - 20/25	3/4"	20	BSP 1"	
1300 - 25	1"	25	BSP 1"	
1300 - 25/20	1"	25	BSP 3/4"	
1300 - 25/32	1"	25	BSP 1.1/4"	
1300 - 32	1.1/4"	32	BSP 1.1/4"	
1300 - 32/40	1.1/4"	32	BSP 1.1/2"	
1300 - 40	1.1/2"	40	BSP 1.1/2"	
1300 - 50	2"	50	BSP 2"	

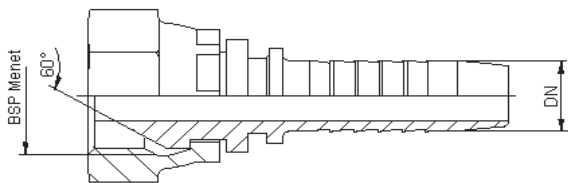

( DKR )  
**Armătură cu piuliță filet în țol BSP con  
 60°**

Număr articol	Diametru furtun		Diametru filet	
	inch	mm (DN)		
1500 - 05	3/16"	5	BSP 1/8"	
1500 - 06	1/4"	6	BSP 1/4"	
1500 - 06/05	1/4"	6	BSP 1/8"	
1500 - 06/10	1/4"	6	BSP 3/8"	
1500 - 08/06	5/16"	8	BSP 1/4"	
1500 - 08/10	5/16"	8	BSP 3/8"	
1500 - 10	3/8"	10	BSP 3/8"	
1500 - 10/12	3/8"	10	BSP 1/2"	
1500 - 12	1/2"	12	BSP 1/2"	
1500 - 12/10	1/2"	12	BSP 3/8"	
1500 - 12/16	1/2"	12	BSP 5/8"	
1500 - 16	5/8"	16	BSP 5/8"	
1500 - 16/20	5/8"	16	BSP 3/4"	
1500 - 20	3/4"	20	BSP 3/4"	
1500 - 20/25	3/4"	20	BSP 1"	
1500 - 25	1"	25	BSP 1"	
1500 - 25/20	1"	25	BSP 3/4"	
1500 - 25/32	1"	25	BSP 1.1/4"	
1500 - 32	1.1/4"	32	BSP 1.1/4"	
1500 - 32/40	1.1/4"	32	BSP 1.1/2"	
1500 - 40	1.1/2"	40	BSP 1.1/2"	
1500 - 50	2"	50	BSP 2"	

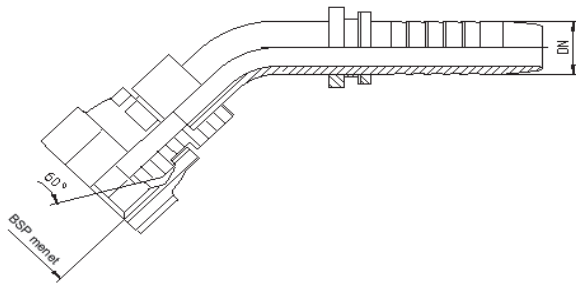

( DKR )  
**Armătură cu piuliță filet în țol BSP con  
 60° la 45°**

Număr articol	Diametru furtun		Diametru filet	
	inch	mm (DN)		
1500 - 05 - 45	3/16"	5	BSP 1/8"	
1500 - 06 - 45	1/4"	6	BSP 1/4"	
1500 - 06/05 - 45	1/4"	6	BSP 1/8"	
1500 - 06/10 - 45	1/4"	6	BSP 3/8"	
1500 - 08/06 - 45	5/16"	8	BSP 1/4"	
1500 - 08/10 - 45	5/16"	8	BSP 3/8"	
1500 - 10 - 45	3/8"	10	BSP 3/8"	
1500 - 10/12 - 45	3/8"	10	BSP 1/2"	
1500 - 12 - 45	1/2"	12	BSP 1/2"	
1500 - 12/10 - 45	1/2"	12	BSP 3/8"	
1500 - 12/16 - 45	1/2"	12	BSP 5/8"	
1500 - 16 - 45	5/8"	16	BSP 5/8"	
1500 - 16/20 - 45	5/8"	16	BSP 3/4"	
1500 - 20 - 45	3/4"	20	BSP 3/4"	
1500 - 20/25 - 45	3/4"	20	BSP 1"	
1500 - 25 - 45	1"	25	BSP 1"	
1500 - 25/20 - 45	1"	25	BSP 3/4"	
1500 - 25/32 - 45	1"	25	BSP 1.1/4"	
1500 - 32 - 45	1.1/4"	32	BSP 1.1/4"	
1500 - 32/40 - 45	1.1/4"	32	BSP 1.1/2"	
1500 - 40 - 45	1.1/2"	40	BSP 1.1/2"	
1500 - 50 - 45	2"	50	BSP 2"	

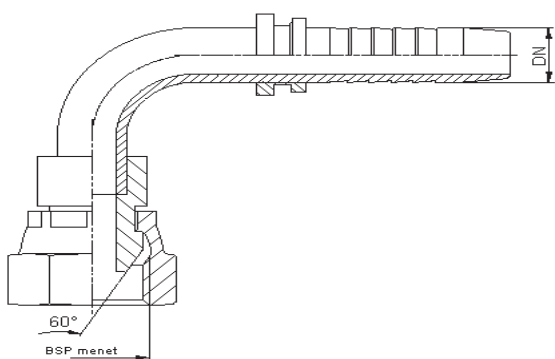

( DKR )  
**Armătură cu piuliță filet în țol BSP con  
 60° la 90°**

Număr articol	Diametru furtun		Diametru filet	
	inch	mm (DN)		
1500 - 05 - 90	3/16"	5	BSP 1/8"	
1500 - 06 - 90	1/4"	6	BSP 1/4"	
1500 - 06/05 - 90	1/4"	6	BSP 1/8"	
1500 - 06/10 - 90	1/4"	6	BSP 3/8"	
1500 - 08/06 - 90	5/16"	8	BSP 1/4"	
1500 - 08/10 - 90	5/16"	8	BSP 3/8"	
1500 - 10 - 90	3/8"	10	BSP 3/8"	
1500 - 10/12 - 90	3/8"	10	BSP 1/2"	
1500 - 12 - 90	1/2"	12	BSP 1/2"	
1500 - 12/10 - 90	1/2"	12	BSP 3/8"	
1500 - 12/16 - 90	1/2"	12	BSP 5/8"	
1500 - 16 - 90	5/8"	16	BSP 5/8"	
1500 - 16/20 - 90	5/8"	16	BSP 3/4"	
1500 - 20 - 90	3/4"	20	BSP 3/4"	
1500 - 20/25 - 90	3/4"	20	BSP 1"	
1500 - 25 - 90	1"	25	BSP 1"	
1500 - 25/20 - 90	1"	25	BSP 3/4"	
1500 - 25/32 - 90	1"	25	BSP 1.1/4"	
1500 - 32 - 90	1.1/4"	32	BSP 1.1/4"	
1500 - 32/40 - 90	1.1/4"	32	BSP 1.1/2"	
1500 - 40 - 90	1.1/2"	40	BSP 1.1/2"	
1500 - 50 - 90	2"	50	BSP 2"	

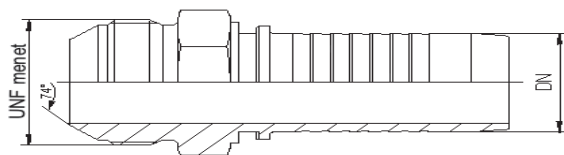

( DKJ )  
**Armătură cu filet exterior in țol cu con  
 74°  
 ( standard JIC )**

Număr articol	Diametru furtun		Diametru filet	
	inch	mm (DN)		
1310 - 05/06	3/16"	5	UNF 7/16"-20	
1310 - 06	1/4"	6	UNF 7/16"-20	
1310 - 06/08	1/4"	6	UNF 1/2"-20	
1310 - 06/10	1/4"	6	UNF 9/16"-18	
1310 - 08	5/16"	8	UNF 1/2"-20	
1310 - 08/10	5/16"	8	UNF 9/16"-18	
1310 - 08/12	5/16"	8	UNF 3/4"-16	
1310 - 10	3/8"	10	UNF 9/16"-18	
1310 - 10/12	3/8"	10	UNF 3/4"-16	
1310 - 10/16	3/8"	10	UNF 7/8"-14	
1310 - 12	1/2"	12	UNF 3/4"-16	
1310 - 12/16	1/2"	12	UNF 7/8"-14	
1310 - 12/20	1/2"	12	UNF 1.1/16"-12	
1310 - 16	5/8"	16	UNF 7/8"-14	
1310 - 16/20	5/8"	16	UNF 1.1/16"-12	
1310 - 20	3/4"	20	UNF 1.1/16"-12	
1310 - 20/16	3/4"	20	UNF 7/8"-14	
1310 - 20/25	3/4"	20	UNF 1.5/16"-12	
1310 - 25	1"	25	UNF 1.5/16"-12	
1310 - 25/32	1"	25	UNF 1.5/8"-12	
1310 - 32	1.1/4"	32	UNF 1.5/8"-12	
1310 - 32/40	1.1/4"	32	UNF 1.7/8"-12	
1310 - 40	1.1/2"	40	UNF 1.7/8"-12	
1310 - 50	2"	50	UNF 2.1/2"-12	

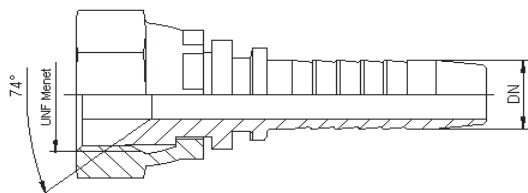

( DKJ )  
**Armătură cu piulițăfilet în țol UNF cu  
 con interior 74°  
 (standard JIC )**

Număr articol	Diametru furtun		Diametru filet	
	inch	mm (DN)		
1510 - 05/06	3/16"	5	UNF 7/16"-20	
1510 - 06	1/4"	6	UNF 7/16"-20	
1510 - 06/08	1/4"	6	UNF 1/2"-20	
1510 - 06/10	1/4"	6	UNF 9/16"-18	
1510 - 08	5/16"	8	UNF 1/2"-20	
1510 - 08/10	5/16"	8	UNF 9/16"-18	
1510 - 08/12	5/16"	8	UNF 3/4"-16	
1510 - 10	3/8"	10	UNF 9/16"-18	
1510 - 10/12	3/8"	10	UNF 3/4"-16	
1510 - 10/16	3/8"	10	UNF 7/8"-14	
1510 - 12	1/2"	12	UNF 3/4"-16	
1510 - 12/16	1/2"	12	UNF 7/8"-14	
1510 - 12/20	1/2"	12	UNF 1.1/16"-12	
1510 - 16	5/8"	16	UNF 7/8"-14	
1510 - 16/20	5/8"	16	UNF 1.1/16"-12	
1510 - 20	3/4"	20	UNF 1.1/16"-12	
1510 - 20/16	3/4"	20	UNF 7/8"-14	
1510 - 20/25	3/4"	20	UNF 1.5/16"-12	
1510 - 25	1"	25	UNF 1.5/16"-12	
1510 - 25/32	1"	25	UNF 1.5/8"-12	
1510 - 32	1.1/4"	32	UNF 1.5/8"-12	
1510 - 32/40	1.1/4"	32	UNF 1.7/8"-12	
1510 - 40	1.1/2"	40	UNF 1.7/8"-12	
1510 - 50	2"	50	UNF 2.1/2"-12	

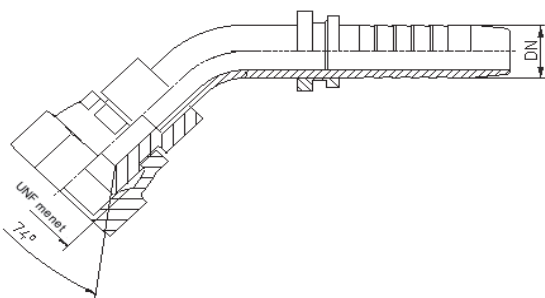

( DKJ )  
**Armătură cu piuliță filet în țol UNF cu  
 con interior 74° la 45°  
 (standard JIC )**

Număr articol	Diametru furtun		Diametru filet
	inch	mm (DN)	
1510 - 05/06 - 45	3/16"	5	UNF 7/16"-20
1510 - 06 - 45	1/4"	6	UNF 7/16"-20
1510 - 06/08 - 45	1/4"	6	UNF 1/2"-20
1510 - 06/10 - 45	1/4"	6	UNF 9/16"-18
1510 - 08 - 45	5/16"	8	UNF 1/2"-20
1510 - 08/10 - 45	5/16"	8	UNF 9/16"-18
1510 - 08/12 - 45	5/16"	8	UNF 3/4"-16
1510 - 10 - 45	3/8"	10	UNF 9/16"-18
1510 - 10/12 - 45	3/8"	10	UNF 3/4"-16
1510 - 10/16 - 45	3/8"	10	UNF 7/8"-14
1510 - 12 - 45	1/2"	12	UNF 3/4"-16
1510 - 12/16 - 45	1/2"	12	UNF 7/8"-14
1510 - 12/20 - 45	1/2"	12	UNF 1.1/16"-12
1510 - 16 - 45	5/8"	16	UNF 7/8"-14
1510 - 16/20 - 45	5/8"	16	UNF 1.1/16"-12
1510 - 20 - 45	3/4"	20	UNF 1.1/16"-12
1510 - 20/16 - 45	3/4"	20	UNF 7/8"-14
1510 - 20/25 - 45	3/4"	20	UNF 1.5/16"-12
1510 - 25 - 45	1"	25	UNF 1.5/16"-12
1510 - 25/32 - 45	1"	25	UNF 1.5/8"-12
1510 - 32 - 45	1.1/4"	32	UNF 1.5/8"-12
1510 - 32/40 - 45	1.1/4"	32	UNF 1.7/8"-12
1510 - 40 - 45	1.1/2"	40	UNF 1.7/8"-12
1510 - 50 - 45	2"	50	UNF 2.1/2"-12

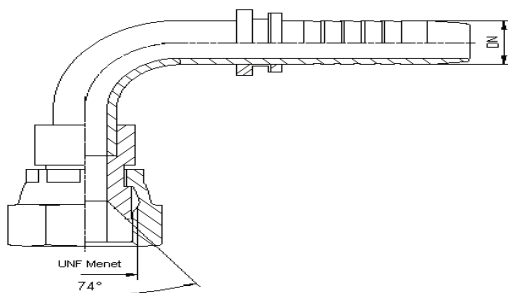

( DKJ )  
**Armătură cu piuliță filet în țol UNF cu  
 con interior 74° la 90° ( standard JIC )**

Număr articol	Diametru furtun		Diametru filet	
	inch	mm (DN)		
1510 - 05/06 - 90	3/16"	5	UNF 7/16"-20	
1510 - 06 - 90	1/4"	6	UNF 7/16"-20	
1510 - 06/08 - 90	1/4"	6	UNF 1/2"-20	
1510 - 06/10 - 90	1/4"	6	UNF 9/16"-18	
1510 - 08 - 90	5/16"	8	UNF 1/2"-20	
1510 - 08/10 - 90	5/16"	8	UNF 9/16"-18	
1510 - 08/12 - 90	5/16"	8	UNF 3/4"-16	
1510 - 10 - 90	3/8"	10	UNF 9/16"-18	
1510 - 10/12 - 90	3/8"	10	UNF 3/4"-16	
1510 - 10/16 - 90	3/8"	10	UNF 7/8"-14	
1510 - 12 - 90	1/2"	12	UNF 3/4"-16	
1510 - 12/16 - 90	1/2"	12	UNF 7/8"-14	
1510 - 12/20 - 90	1/2"	12	UNF 1.1/16"-12	
1510 - 16 - 90	5/8"	16	UNF 7/8"-14	
1510 - 16/20 - 90	5/8"	16	UNF 1.1/16"-12	
1510 - 20 - 90	3/4"	20	UNF 1.1/16"-12	
1510 - 20/16 - 90	3/4"	20	UNF 7/8"-14	
1510 - 20/25 - 90	3/4"	20	UNF 1.5/16"-12	
1510 - 25 - 90	1"	25	UNF 1.5/16"-12	
1510 - 25/32 - 90	1"	25	UNF 1.5/8"-12	
1510 - 32 - 90	1.1/4"	32	UNF 1.5/8"-12	
1510 - 32/40 - 90	1.1/4"	32	UNF 1.7/8"-12	
1510 - 40 - 90	1.1/2"	40	UNF 1.7/8"-12	
1510 - 50 - 90	2"	50	UNF 2.1/2"-12	

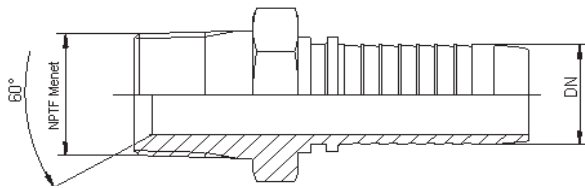

( AGN )  
**Armătură cu filet exterior în țol NPT cu con**

Număr articol	Diametru furtun		Diametru filet	
	inch	mm (DN)		
1320 - 05	3/16"	5	NPT 1/8"	
1320 - 06	1/4"	6	NPT 1/4"	
1320 - 06/05	1/4"	6	NPT 1/8"	
1320 - 06/10	1/4"	6	NPT 3/8"	
1320 - 08/06	5/16"	8	NPT 1/4"	
1320 - 08/10	5/16"	8	NPT 3/8"	
1320 - 10	3/8"	10	NPT 3/8"	
1320 - 10/06	3/8"	10	NPT 1/4"	
1320 - 10/12	3/8"	10	NPT 1/2"	
1320 - 12	1/2"	12	NPT 1/2"	
1320 - 12/10	1/2"	12	NPT 3/8"	
1320 - 16/12	5/8"	16	NPT 1/2"	
1320 - 16/20	5/8"	16	NPT 3/4"	
1320 - 20	3/4"	20	NPT 3/4"	
1320 - 20/25	3/4"	20	NPT 1"	
1320 - 25	1"	25	NPT 1"	
1320 - 32	1.1/4"	32	NPT 1.1/4"	
1320 - 40	1.1/2"	40	NPT 1.1/2"	
1320 - 50	2"	50	NPT 2"	

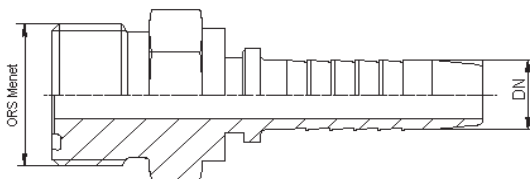

( ORS )  
**Armătură cu filet exterior în țol UNF  
 cu etanșare în plat**

Număr articol	Diametru furtun		Diametru filet	
	inch	mm (DN)		
1311 - 06	1/4"	6	UN 9/16"-18	
1311 - 06/10	1/4"	6	UN 11/16"-16	
1311 - 08/10	5/16"	8	UN 11/16"-16	
1311 - 08/12	5/16"	8	UN 13/16"-16	
1311 - 10	3/8"	10	UN 11/16"-16	
1311 - 10/12	3/8"	10	UN 13/16"-16	
1311 - 10/16	3/8"	10	UN 1"-14	
1311 - 12	1/2"	12	UN 13/16"-16	
1311 - 12/16	1/2"	12	UN 1"-14	
1311 - 12/20	1/2"	12	UN 1.3/16"-12	
1311 - 16	5/8"	16	UN 1"-14	
1311 - 16/20	5/8"	16	UN 1.3/16"-12	
1311 - 20	3/4"	20	UN 1.3/16"-12	
1311 - 20/16	3/4"	20	UN 1"-14	
1311 - 20/25	3/4"	20	UN 1.7/16"-12	
1311 - 25	1"	25	UN 1.7/16"-12	
1311 - 25/32	1"	25	UN 1.11/16"-12	
1311 - 32	1.1/4"	32	UN 1.11/16"-12	
1311 - 32/40	1.1/4"	32	UN 2"-12	
1311 - 40	1.1/2"	40	UN 2"-12	

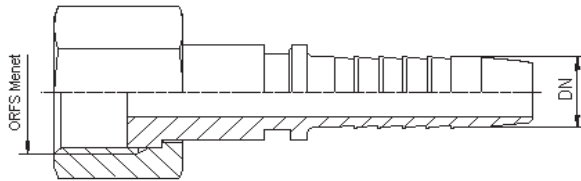

( ORFS )  
**Armătură cu piuliță cu filet în țol UNF cu etanșare în plat**

Număr articol	Diametru furtun		Diametru filet	
	inch	mm (DN)		
1511 - 06	1/4"	6	UN 9/16"-18	
1511 - 06/10	1/4"	6	UN 11/16"-16	
1511 - 08/10	5/16"	8	UN 11/16"-16	
1511 - 08/12	5/16"	8	UN 13/16"-16	
1511 - 10	3/8"	10	UN 11/16"-16	
1511 - 10/12	3/8"	10	UN 13/16"-16	
1511 - 10/16	3/8"	10	UN 1"-14	
1511 - 12	1/2"	12	UN 13/16"-16	
1511 - 12/16	1/2"	12	UN 1"-14	
1511 - 12/20	1/2"	12	UN 1.3/16"-12	
1511 - 16	5/8"	16	UN 1"-14	
1511 - 16/20	5/8"	16	UN 1.3/16"-12	
1511 - 20	3/4"	20	UN 1.3/16"-12	
1511 - 20/16	3/4"	20	UN 1"-14	
1511 - 20/25	3/4"	20	UN 1.7/16"-12	
1511 - 25	1"	25	UN 1.7/16"-12	
1511 - 25/32	1"	25	UN 1.11/16"-12	
1511 - 32	1.1/4"	32	UN 1.11/16"-12	
1511 - 32/40	1.1/4"	32	UN 2"-12	
1511 - 40	1.1/2"	40	UN 2"-12	

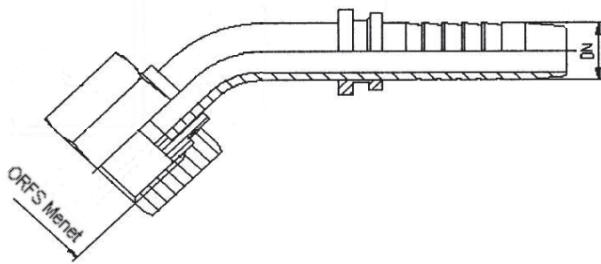

**( ORFS )**  
**Armătură cu piuliță cu filet în țol UNF cu**  
**etanșare în plat la45°**

Număr articol	Diametru furtun		Diametru filet	
	inch	mm (DN)		
1511 - 06 - 45	1/4"	6	UN 9/16"-18	
1511 - 06/10 - 45	1/4"	6	UN 11/16"-16	
1511 - 08/10 - 45	5/16"	8	UN 11/16"-16	
1511 - 08/12 - 45	5/16"	8	UN 13/16"-16	
1511 - 10 - 45	3/8"	10	UN 11/16"-16	
1511 - 10/12 - 45	3/8"	10	UN 13/16"-16	
1511 - 10/16 - 45	3/8"	10	UN 1"-14	
1511 - 12 - 45	1/2"	12	UN 13/16"-16	
1511 - 12/16 - 45	1/2"	12	UN 1"-14	
1511 - 12/20 - 45	1/2"	12	UN 1.3/16"-12	
1511 - 16 - 45	5/8"	16	UN 1"-14	
1511 - 16/20 - 45	5/8"	16	UN 1.3/16"-12	
1511 - 20 - 45	3/4"	20	UN 1.3/16"-12	
1511 - 20/16 - 45	3/4"	20	UN 1"-14	
1511 - 20/25 - 45	3/4"	20	UN 1.7/16"-12	
1511 - 25 - 45	1"	25	UN 1.7/16"-12	
1511 - 25/32 - 45	1"	25	UN 1.11/16"-12	
1511 - 32 - 45	1.1/4"	32	UN 1.11/16"-12	
1511 - 32/40 - 45	1.1/4"	32	UN 2"-12	
1511 - 40 - 45	1.1/2"	40	UN 2"-12	

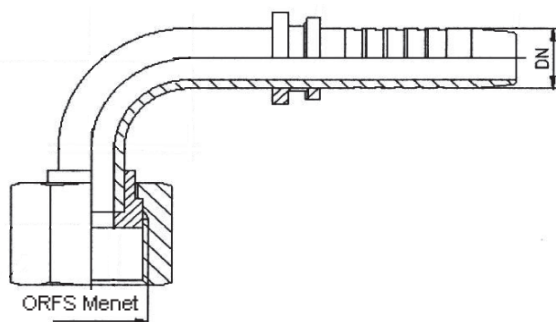

**( ORFS )**  
**Armătură cu piuliță cu filet în țol UNF cu**  
**etanșare în plat la 90°**

Număr articol	Diametru furtun		Diametru filet	
	inch	mm (DN)		
1511 - 06 - 90	1/4"	6	UN 9/16"-18	
1511 - 06/10 - 90	1/4"	6	UN 11/16"-16	
1511 - 08/10 - 90	5/16"	8	UN 11/16"-16	
1511 - 08/12 - 90	5/16"	8	UN 13/16"-16	
1511 - 10 - 90	3/8"	10	UN 11/16"-16	
1511 - 10/12 - 90	3/8"	10	UN 13/16"-16	
1511 - 10/16 - 90	3/8"	10	UN 1"-14	
1511 - 12 - 90	1/2"	12	UN 13/16"-16	
1511 - 12/16 - 90	1/2"	12	UN 1"-14	
1511 - 12/20 - 90	1/2"	12	UN 1.3/16"-12	
1511 - 16 - 90	5/8"	16	UN 1"-14	
1511 - 16/20 - 90	5/8"	16	UN 1.3/16"-12	
1511 - 20 - 90	3/4"	20	UN 1.3/16"-12	
1511 - 20/16 - 90	3/4"	20	UN 1"-14	
1511 - 20/25 - 90	3/4"	20	UN 1.7/16"-12	
1511 - 25 - 90	1"	25	UN 1.7/16"-12	
1511 - 25/32 - 90	1"	25	UN 1.11/16"-12	
1511 - 32 - 90	1.1/4"	32	UN 1.11/16"-12	
1511 - 32/40 - 90	1.1/4"	32	UN 2"-12	
1511 - 40 - 90	1.1/2"	40	UN 2"-12	

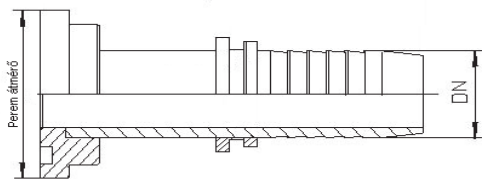

( SFL )  
**Armătură SAE 3000 PSI cu flanșă**

Număr articol	Diametru furtun		Perem átmérő (mm)
	inch	mm (DN)	
1404 - 12	1/2"	12	Ø 30,2
1404 - 12/20	1/2"	12	Ø 38,1
1404 - 16/12	5/8"	16	Ø 30,2
1404 - 16/20	5/8"	16	Ø 38,1
1404 - 20	3/4"	20	Ø 38,1
1404 - 20/25	3/4"	20	Ø 44,5
1404 - 25	1"	25	Ø 44,5
1404 - 25/20	1"	25	Ø 38,1
1404 - 25/32	1"	25	Ø 50,8
1404 - 32	1.1/4"	32	Ø 50,8
1404 - 32/40	1.1/4"	32	Ø 60,3
1404 - 40	1.1/2"	40	Ø 60,3
1404 - 50	2"	50	Ø 71,4

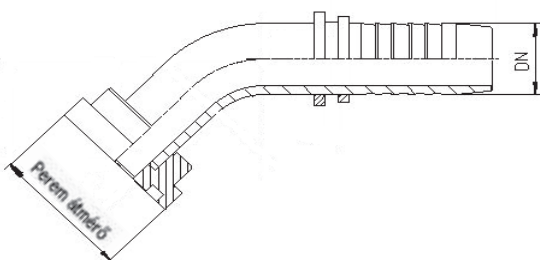

( SFL )  
**Armătură SAE 3000 PSI cu flanșă SAE  
 3000 PSI la 45°**

Număr articol	Diametru furtun		Diametru flanșă mm)
	inch	mm (DN)	
1404 - 12 - 45	1/2"	12	Ø 30,2
1404 - 12/20 - 45	1/2"	12	Ø 38,1
1404 - 16/12 - 45	5/8"	16	Ø 30,2
1404 - 16/20 - 45	5/8"	16	Ø 38,1
1404 - 20 - 45	3/4"	20	Ø 38,1
1404 - 20/25 - 45	3/4"	20	Ø 44,5
1404 - 25 - 45	1"	25	Ø 44,5
1404 - 25/20 - 45	1"	25	Ø 38,1
1404 - 25/32 - 45	1"	25	Ø 50,8
1404 - 32 - 45	1.1/4"	32	Ø 50,8
1404 - 32/40 - 45	1.1/4"	32	Ø 60,3
1404 - 40 - 45	1.1/2"	40	Ø 60,3
1404 - 50 - 45	2"	50	Ø 71,4

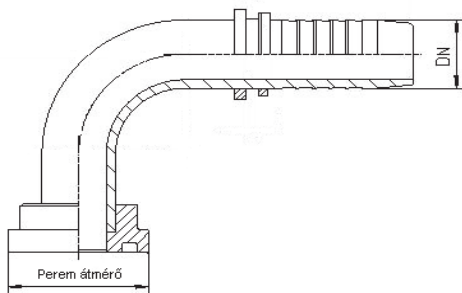

( SFL )  
**Armătură SAE 3000 PSI cu flanșă SAE  
 3000 PSI la 90°**

Număr articol	Diametru furtun		Diametru flanșă (mm)	
	inch	mm (DN)		
1404 - 12 - 90	1/2"	12	Ø 30,2	
1404 - 12/20 - 90	1/2"	12	Ø 38,1	
1404 - 16/12 - 90	5/8"	16	Ø 30,2	
1404 - 16/20 - 90	5/8"	16	Ø 38,1	
1404 - 20 - 90	3/4"	20	Ø 38,1	
1404 - 20/25 - 90	3/4"	20	Ø 44,5	
1404 - 25 - 90	1"	25	Ø 44,5	
1404 - 25/20 - 90	1"	25	Ø 38,1	
1404 - 25/32 - 90	1"	25	Ø 50,8	
1404 - 32 - 90	1.1/4"	32	Ø 50,8	
1404 - 32/40 - 90	1.1/4"	32	Ø 60,3	
1404 - 40 - 90	1.1/2"	40	Ø 60,3	
1404 - 50 - 90	2"	50	Ø 71,4	

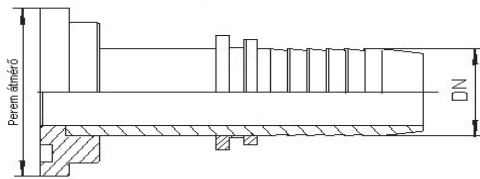

( SFS )  
**Armătură cu flanșă SAE 6000 PSI**

Număr articol	Diametru furtun		Diametru flanșă (mm)
	inch	mm (DN)	
1414 - 12	1/2"	12	Ø 31,7
1414 - 12/20	1/2"	12	Ø 41,3
1414 - 16/12	5/8"	16	Ø 31,7
1414 - 16/20	5/8"	16	Ø 41,3
1414 - 20	3/4"	20	Ø 41,3
1414 - 20/25	3/4"	20	Ø 47,6
1414 - 25	1"	25	Ø 47,6
1414 - 25/20	1"	25	Ø 41,3
1414 - 25/32	1"	25	Ø 54,0
1414 - 32	1.1/4"	32	Ø 54,0
1414 - 32/40	1.1/4"	32	Ø 63,5
1414 - 40	1.1/2"	40	Ø 63,5
1414 - 50	2"	50	Ø 79,4

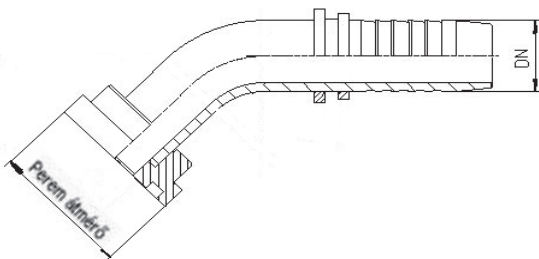

( SFS )  
**Armătură cu flanșă SAE 6000 PSI SAE  
 6000 PSI la 45°**

Număr articol	Diametru furtun		Diametru flanșă (mm)
	inch	mm (DN)	
1414 - 12 - 45	1/2"	12	Ø 31,7
1414 - 12/20 - 45	1/2"	12	Ø 41,3
1414 - 16/12 - 45	5/8"	16	Ø 31,7
1414 - 16/20 - 45	5/8"	16	Ø 41,3
1414 - 20 - 45	3/4"	20	Ø 41,3
1414 - 20/25 - 45	3/4"	20	Ø 47,6
1414 - 25 - 45	1"	25	Ø 47,6
1414 - 25/20 - 45	1"	25	Ø 41,3
1414 - 25/32 - 45	1"	25	Ø 54,0
1414 - 32 - 45	1.1/4"	32	Ø 54,0
1414 - 32/40 - 45	1.1/4"	32	Ø 63,5
1414 - 40 - 45	1.1/2"	40	Ø 63,5
1414 - 50 - 45	2"	50	Ø 79,4

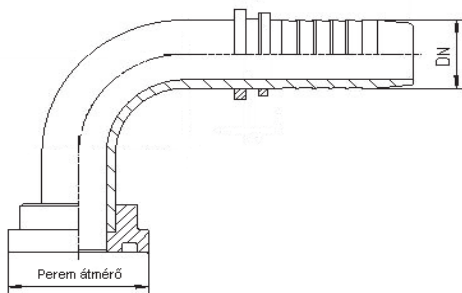

( SFS )  
**Armătură cu flanșă SAE 6000 PSI SAE  
 6000 PSI la 90°**

Număr articol	Diametru furtun		Diametru flanșă (mm)	
	inch	mm (DN)		
1414 - 12 - 90	1/2"	12	Ø 31,7	
1414 - 12/20 - 90	1/2"	12	Ø 41,3	
1414 - 16/12 - 90	5/8"	16	Ø 31,7	
1414 - 16/20 - 90	5/8"	16	Ø 41,3	
1414 - 20 - 90	3/4"	20	Ø 41,3	
1414 - 20/25 - 90	3/4"	20	Ø 47,6	
1414 - 25 - 90	1"	25	Ø 47,6	
1414 - 25/20 - 90	1"	25	Ø 41,3	
1414 - 25/32 - 90	1"	25	Ø 54,0	
1414 - 32 - 90	1.1/4"	32	Ø 54,0	
1414 - 32/40 - 90	1.1/4"	32	Ø 63,5	
1414 - 40 - 90	1.1/2"	40	Ø 63,5	
1414 - 50 - 90	2"	50	Ø 79,4	

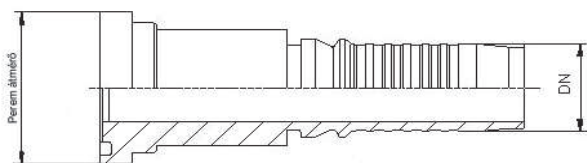

( SFL )  
**Armătură cu flanșă SAE 3000 PSI în  
 varianta antismulgere (4SH)**

Număr articol	Diametru furtun		Diametru flanșă (mm)
	inch	mm (DN)	
1402 - 20	3/4"	20	Ø 38,1
1402 - 20/25	3/4"	20	Ø 44,5
1402 - 25	1"	25	Ø 44,5
1402 - 25/20	1"	25	Ø 38,1
1402 - 25/32	1"	25	Ø 50,8
1402 - 32	1.1/4"	32	Ø 50,8
1402 - 32/40	1.1/4"	32	Ø 60,3
1402 - 40	1.1/2"	40	Ø 60,3
1402 - 40/50	1.1/2"	40	Ø 71,4
1402 - 50	2"	50	Ø 71,4

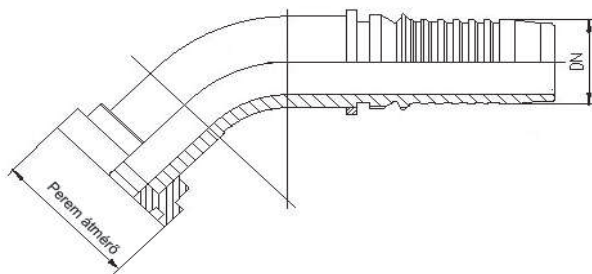

( SFL )  
**Armătură cu flanșă SAE 3000 PSI în  
 varianta antismulgere la 45° (4SH)**

Număr articol	Diametru furtun		Diametru flanșă (mm)
	inch	mm (DN)	
1402 - 20 - 45	3/4"	20	Ø 38,1
1402 - 20/25 - 45	3/4"	20	Ø 44,5
1402 - 25 - 45	1"	25	Ø 44,5
1402 - 25/20 - 45	1"	25	Ø 38,1
1402 - 25/32 - 45	1"	25	Ø 50,8
1402 - 32 - 45	1.1/4"	32	Ø 50,8
1402 - 32/40 - 45	1.1/4"	32	Ø 60,3
1402 - 40 - 45	1.1/2"	40	Ø 60,3
1402 - 40/50 - 45	1.1/2"	40	Ø 71,4
1402 - 50 - 45	2"	50	Ø 71,4

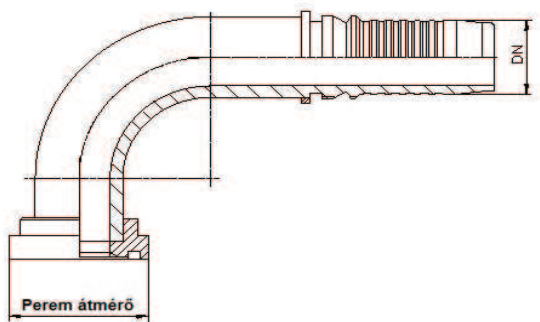

( SFL )  
**Armătură cu flanșă SAE 3000 PSI în  
 varianta antismulgere la 90° (4SH)**

Număr articol	Diametru furtun		Diametru flanșă (mm)	
	inch	mm (DN)		
1402 - 20 - 90	3/4"	20	Ø 38,1	
1402 - 20/25 - 90	3/4"	20	Ø 44,5	
1402 - 25 - 90	1"	25	Ø 44,5	
1402 - 25/20 - 90	1"	25	Ø 38,1	
1402 - 25/32 - 90	1"	25	Ø 50,8	
1402 - 32 - 90	1.1/4"	32	Ø 50,8	
1402 - 32/40 - 90	1.1/4"	32	Ø 60,3	
1402 - 40 - 90	1.1/2"	40	Ø 60,3	
1402 - 40/50 - 90	1.1/2"	40	Ø 71,4	
1402 - 50 - 90	2"	50	Ø 71,4	

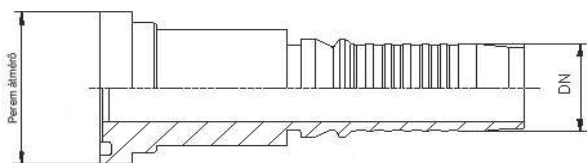

( SFS )  
**Armătură cu flanșă SAE 6000 PSI în  
 varianta antismulgere (4SH)**

Număr articol	Diametru furtun		Diametru flanșă (mm)
	inch	mm (DN)	
1412 - 20	3/4"	20	Ø 41,3
1412 - 20/25	3/4"	20	Ø 47,6
1412 - 25	1"	25	Ø 47,6
1412 - 25/20	1"	25	Ø 41,3
1412 - 25/32	1"	25	Ø 54,0
1412 - 32	1.1/4"	32	Ø 54,0
1412 - 32/40	1.1/4"	32	Ø 63,5
1412 - 40	1.1/2"	40	Ø 63,5
1412 - 40/50	1.1/2"	40	Ø 79,4
1412 - 50	2"	50	Ø 79,4

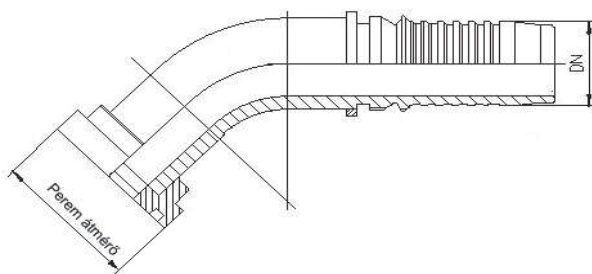

( SFS )  
**Armătură cu flanșă SAE 6000 PSI în  
 varianta antismulgere la 45° (4SH)**

Număr articol	Diametru furtun		Diametru flanșă (mm)
	inch	mm (DN)	
1412 - 20 - 45	3/4"	20	Ø 41,3
1412 - 20/25 - 45	3/4"	20	Ø 47,6
1412 - 25 - 45	1"	25	Ø 47,6
1412 - 25/20 - 45	1"	25	Ø 41,3
1412 - 25/32 - 45	1"	25	Ø 54,0
1412 - 32 - 45	1.1/4"	32	Ø 54,0
1412 - 32/40 - 45	1.1/4"	32	Ø 63,5
1412 - 40 - 45	1.1/2"	40	Ø 63,5
1412 - 40/50 - 45	1.1/2"	40	Ø 79,4
1412 - 50 - 45	2"	50	Ø 79,4

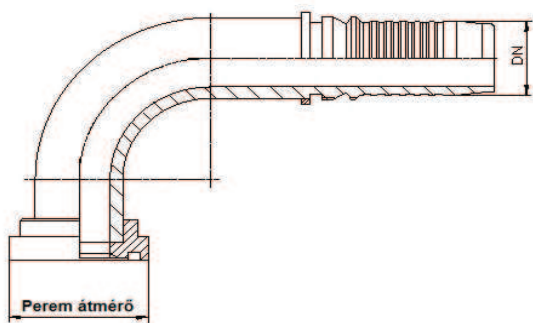

( SFS )  
**Armătură cu flanșă SAE 6000 PSI în  
 varianta antismulgere la 90° (4SH)**

Număr articol	Diametru furtun		Diametru flanșă (mm)	
	inch	mm (DN)		
1412 - 20 - 90	3/4"	20	Ø 41,3	
1412 - 20/25 - 90	3/4"	20	Ø 47,6	
1412 - 25 - 90	1"	25	Ø 47,6	
1412 - 25/20 - 90	1"	25	Ø 41,3	
1412 - 25/32 - 90	1"	25	Ø 54,0	
1412 - 32 - 90	1.1/4"	32	Ø 54,0	
1412 - 32/40 - 90	1.1/4"	32	Ø 63,5	
1412 - 40 - 90	1.1/2"	40	Ø 63,5	
1412 - 40/50 - 90	1.1/2"	40	Ø 79,4	
1412 - 50 - 90	2"	50	Ø 79,4	

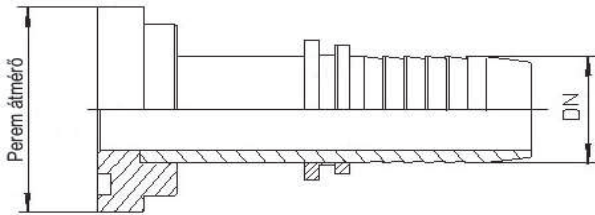

( CAT )  
Armătură cu flanșă CATERPILLAR

Număr articol	Diametru furtun		Diametru flanșă (mm)
	inch	mm (DN)	
1411 - 20	3/4"	20	Ø 41,3
1411 - 20/25	3/4"	20	Ø 47,6
1411 - 25	1"	25	Ø 47,6
1411 - 25/20	1"	25	Ø 41,3
1411 - 25/32	1"	25	Ø 54,0
1411 - 32	1.1/4"	32	Ø 54,0
1411 - 32/40	1.1/4"	32	Ø 63,5
1411 - 40	1.1/2"	40	Ø 63,5
1411 - 50	2"	50	Ø 79,4

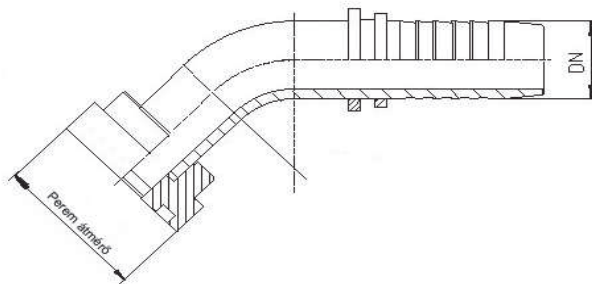

( CAT )  
Armătură cu flanșă CATERPILLAR la 45°

Număr articol	Diametru furtun		Diametru flanșă (mm)
	inch	mm (DN)	
1411 - 20 - 45	3/4"	20	Ø 41,3
1411 - 20/25 - 45	3/4"	20	Ø 47,6
1411 - 25 - 45	1"	25	Ø 47,6
1411 - 25/20 - 45	1"	25	Ø 41,3
1411 - 25/32 - 45	1"	25	Ø 54,0
1411 - 32 - 45	1.1/4"	32	Ø 54,0
1411 - 32/40 - 45	1.1/4"	32	Ø 63,5
1411 - 40 - 45	1.1/2"	40	Ø 63,5
1411 - 50 - 45	2"	50	Ø 79,4

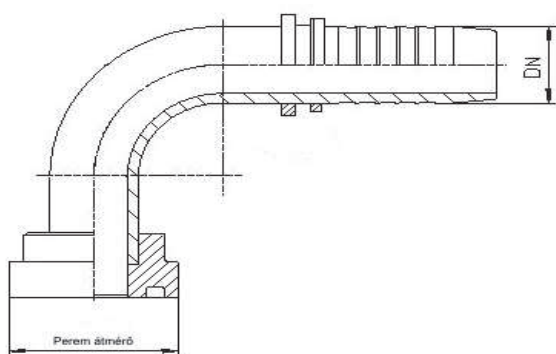

( CAT )  
**Armătură cu flanșă CATERPILLAR la 90°**

Număr articol	Diametru furtun		Diametru flanșă (mm)	
	inch	mm (DN)		
1411 - 20 - 90	3/4"	20	Ø 41,3	
1411 - 20/25 - 90	3/4"	20	Ø 47,6	
1411 - 25 - 90	1"	25	Ø 47,6	
1411 - 25/20 - 90	1"	25	Ø 41,3	
1411 - 25/32 - 90	1"	25	Ø 54,0	
1411 - 32 - 90	1.1/4"	32	Ø 54,0	
1411 - 32/40 - 90	1.1/4"	32	Ø 63,5	
1411 - 40 - 90	1.1/2"	40	Ø 63,5	
1411 - 50 - 90	2"	50	Ø 79,4	

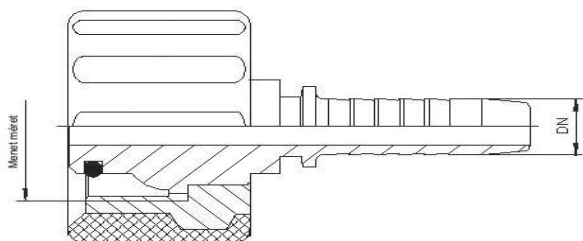

**(WGN)**  
**Armătură pentru furtune de spălat cu  
 filet M 22x1,5**

Număr articol	Diametru furtun		Diametru filet	
	inch	mm (DN)		
1700 - 06 / ÜM	1/4"	06	M 22x1,5	
1700 - 08 / ÜM	5/16"	08	M 22x1,5	
1700 - 10 / ÜM	3/8"	10	M 22x1,5	

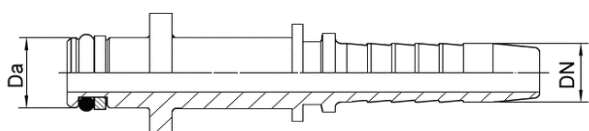

**(WGR)**  
**Armătură pentru furtune de spălat  
 antirăsucire pentru mașini de uz casnic**

Număr articol	Diametru furtun		Diametru filet	
	inch	mm (DN)		
1710 - 06	1/4"	06	Ø 10 mm	
1710 - 08	5/16"	08	Ø 10 mm	

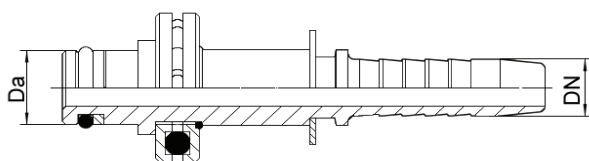

**(WGR)**  
**Armătură pentru furtune de spălat  
 antirăsucire pentru aparate industriale**

Număr articol	Diametru furtun		Diametru filet	
	inch	mm (DN)		
1711 - 06 - CS	1/4"	06	Ø 11 mm	
1711 - 08 - CS	5/16"	08	Ø 11 mm	

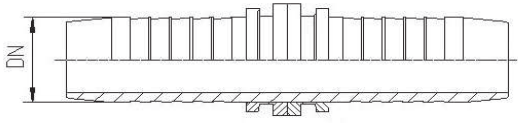

**Adăugare la furtune hidraulice**

Număr articol	Diametru furtun			
	inch	mm (DN)		
1001 - 06	1/4"	06		
1001 - 08	8/16"	08		
1001 - 10	3/8"	10		
1001 - 12	1/2"	12		
1001 - 16	5/8"	16		
1001 - 20	3/4"	20		
1001 - 25	1"	25		

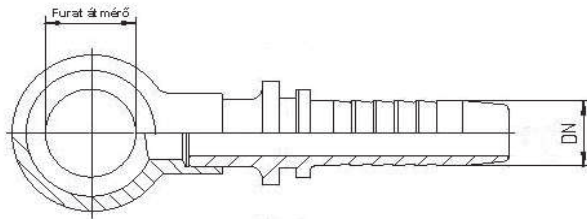

**(RNM)**  
**Armătură tip inel pentru șurub cu filet**  
**metric**

Număr articol	Diametru furtun		Diametru interior inel	
	inch	mm (DN)		
6000 - 05	3/16"	5	Ø 10 mm	
6000 - 06	1/4"	6	Ø 12 mm	
6000 - 06/05	1/4"	6	Ø 10 mm	
6000 - 06/08	1/4"	6	Ø 14 mm	
6000 - 08	5/16"	8	Ø 14 mm	
6000 - 08/06	5/16"	8	Ø 12 mm	
6000 - 08/10	5/16"	8	Ø 16 mm	
6000 - 10	3/8"	10	Ø 16 mm	
6000 - 10/08	3/8"	10	Ø 14 mm	
6000 - 10/12	3/8"	10	Ø 18 mm	
6000 - 12	1/2"	12	Ø 18 mm	
6000 - 12/10	1/2"	12	Ø 16 mm	
6000 - 12/16	1/2"	12	Ø 22 mm	
6000 - 16	5/8"	16	Ø 22 mm	
6000 - 16/20	5/8"	16	Ø 26 mm	
6000 - 20	3/4"	20	Ø 26 mm	
6000 - 20/25	3/4"	20	Ø 30 mm	
6000 - 25	1"	25	Ø 30 mm	
6000 - 25/20	1"	25	Ø 26 mm	

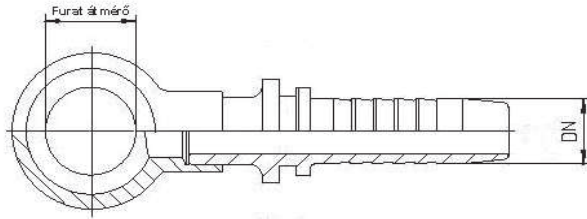

**(RGM)**  
**Armătură tip inel pentru surub cu filet**  
**BSP**

Număr articol	Diametru furtun		Diametru interior	
	inch	mm (DN)		
6100 - 06	1/4"	6	Ø 1/4"	
6100 - 08/06	5/16"	8	Ø 1/4"	
6100 - 08/10	5/16"	8	Ø 3/8"	
6100 - 10	3/8"	10	Ø 3/8"	
6100 - 10/12	3/8"	10	Ø 1/2"	
6100 - 12	1/2"	12	Ø 1/2"	
6100 - 12/10	1/2"	12	Ø 3/8"	
6100 - 12/16	1/2"	12	Ø 5/8"	
6100 - 16	5/8"	16	Ø 5/8"	
6100 - 16/20	5/8"	16	Ø 3/4"	
6100 - 20	3/4"	20	Ø 3/4"	
6100 - 20/25	3/4"	20	Ø 1"	
6100 - 25	1"	25	Ø 1"	
6100 - 25/20	1"	25	Ø 3/4"	